

Portable Compressors MOBILAIR M122

With the world-renowned SIGMA PROFILE 
Free air delivery 11.1 m³/min



Made in Germany



KAESER's renowned MOBILAIR range of portable compressors is manufactured in a state-of-the-art production facility located directly next to the KAESER main plant in Coburg, Northern Bavaria. Equipped with the very latest technology, the recently modernised portable compressor plant boasts TÜV (German Technical Inspection Agency) certified sound testing facilities for free-field sound level measurement, an advanced powder coating installation and

highly efficient production logistics. With minimal turn-around time, KAESER's qualified personnel are able to assemble portable compressors of all sizes and equipment levels to suit our customers' specific needs.

Maximum versatility

The MOBILAIR M 122 is in a class of its own when it comes to versatility, as it can be specifically tailored to meet the needs of the relevant application.

Options include air treatment components, a choice of a fully galvanised chassis with overrun brake and a fixed or height adjustable tow bar, or stationary versions either mounted on skids or machine mountings.

A look under the enclosure

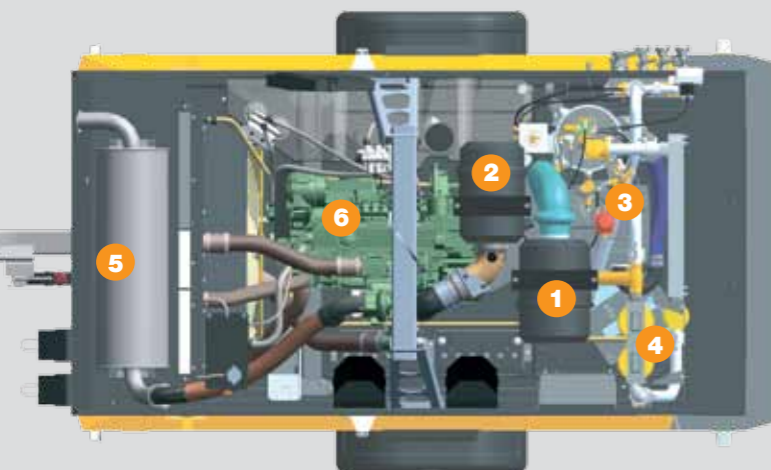

MOBILAIR M 122 – Superior power and flexibility



- 1 Compressor air filter
- 2 Engine air filter
- 3 SIGMA airend
- 4 Compressed air treatment (Optional)
- 5 Internal exhaust silencer (protected from potential damage)
- 6 Diesel engine



Proportional controller with manual control*

For added flexibility, a manual wheel control on the proportional controller enables infinitely variable pressure adjustment.

*) available with 10 to 14 bar versions



Dedicated intake filter for motor and airend

Optimised design and separate air filters considerably enhance reliability and service life. The filters can be changed onsite quickly and simply as required.



Easy to transport

The M 122 features a fully galvanised Alko chassis as standard. This not only ensures long-term value retention, but also makes transportation simple – a truck is not required to tow the unit.



The perfect energy-saving combination: Deutz engines and KAESER airends

The powerful combination of an energy-saving Deutz engine and the highly efficient KAESER SIGMA Profile rotary screw airend combines outstanding performance with considerably reduced fuel consumption. The MOBILAIR M 122 can operate at full power for a whole shift without refuelling. The water-cooled Deutz engine complies with exhaust emission regulations and is certified to EC directive 2004/26 (Tier III A) and USA-

EPA (TIER III). Furthermore, users not only benefit from the quality of two world-class products, but can also rely on the comprehensive KAESER and Deutz global service networks to ensure maximum machine availability.

MOBILAIR M 122 – Perfect performance



Large capacity, transparent fuel tank

When fully filled, the tank carries sufficient fuel for an entire work shift without the need for refuelling. For ease of operation, an automatic shut-down feature is activated when the fuel level becomes too low.



Tool storage space

The integrated tool box provides generous storage space for all tools and accessories. A second tool box is also optionally available.

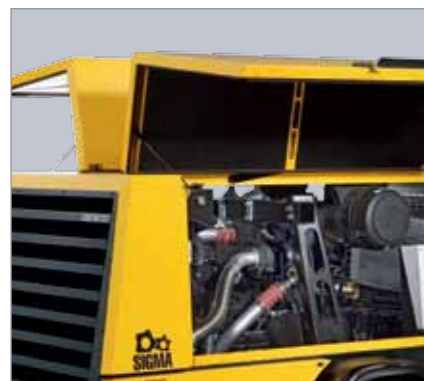

Large gull-wing doors

The M 122's user-friendly design not only ensures simple operation and outstanding manoeuvrability: The unit's large gull-wing doors also provide excellent component accessibility for unrivalled ease of maintenance.



Thermostatic valve for oil temperature regulation

The M 122's automatically controlled thermostatic valve ensures that optimal operating temperature is reached quickly and reliably. It therefore protects the compressor's fluid circulation loop from excessive condensate accumulation. This in turn significantly extends cooling fluid and separator cartridge service life and also enhances the unit's long-term durability.



User-friendly operation

The user-friendly control and instrument panel – which can be equipped with a cover flap if required – enables all information to be viewed at a glance. Features also include automatic monitoring and shutdown. Manual switchover from idling to full load operation ensures a reliable, gentle start when operating the unit in cold ambient conditions.



Cool, clean compressed air

The compressed air is cooled to 7 °C above ambient temperature. Accumulated condensate is able to drain away easily, as the compressed air cooler is installed at an angle, whilst the hot exhaust gasses from the motor are also used to aid condensate evaporation. This design consequently ensures reliable frost prevention during the winter months.



Filter combination

Additional air treatment components need to be installed downstream from the after-cooler and centrifugal separator (e.g. filter combinations for concrete cleaning as per ZTV-SIB) in order to achieve compressed air of a specified quality class. The differential pressure indicator enables filter status to be monitored quickly and easily.









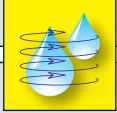

Ambient temperature

Standard models can be used in ambient temperatures ranging from -10 °C to +50 °C, whilst the low temperature versions can be used in temperatures as low as -25 °C.

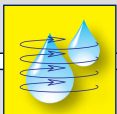
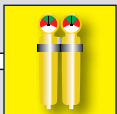

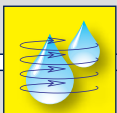

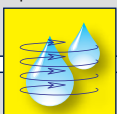
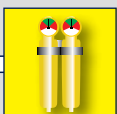
Air treatment systems

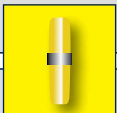
<p>System A</p> <ul style="list-style-type: none"> • Cool • Condensate-free 	<p>Compressed air aftercooler</p>  <p>Centrifugal separator</p> 	<p>Cool, condensate-free compressed air (100 % saturated), for driving air tools and temporarily replacing stationary compressors</p>
<p>System F*</p> <ul style="list-style-type: none"> • Cool • Condensate-free • Filtered 	<p>Compressed air aftercooler</p>  <p>Centrifugal separator</p>  <p>Filters</p> 	<p>Cool, condensate-free compressed air (100% saturated), free from dirt particles and technically oil-free in accordance with applicable regulations</p>
<p>System B</p> <ul style="list-style-type: none"> • Warmed • Dried 	<p>Compressed air aftercooler</p>  <p>Centrifugal separator</p>  <p>Heat recovery</p> 	<p>Dried compressed air, warmed to about 20 °C, for working at sub-zero temperatures and with long air lines</p>
<p>System G*</p> <ul style="list-style-type: none"> • Warmed • Dried • Filtered 	<p>Compressed air aftercooler</p>  <p>Centrifugal separator</p>  <p>Filters</p>  <p>Heat recovery</p> 	<p>Dried compressed air, warmed to at least 20 °C, free from dirt particles and technically oil-free in accordance with applicable regulations</p>
<p>Fresh air</p> <p>As partial flow</p>	<p>Fresh air filter</p> 	<p>Odour-free fresh air connected via a separate quick-release coupling (Only in combination with Option F or Option G)</p>

Additional air treatment systems for the MOBILAIR M 122 are available on request. Please contact Kaeser for further details.

*) From 8.6 bar

Dimensions

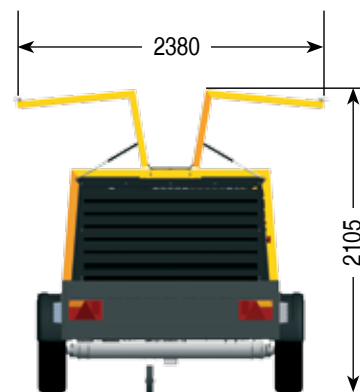
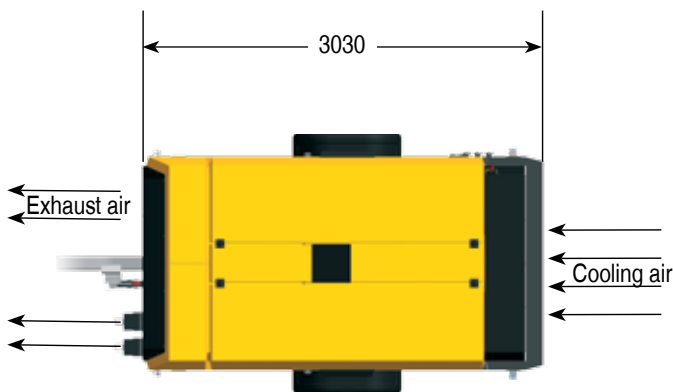
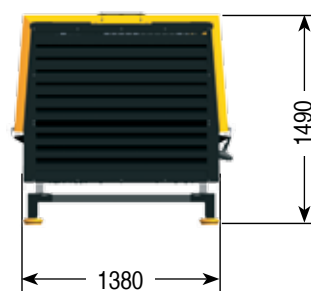
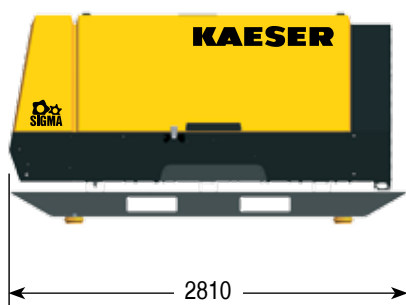
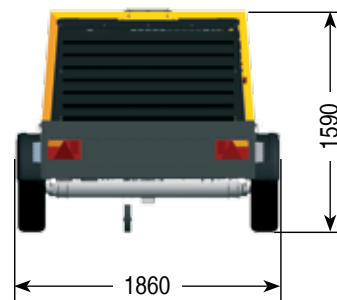
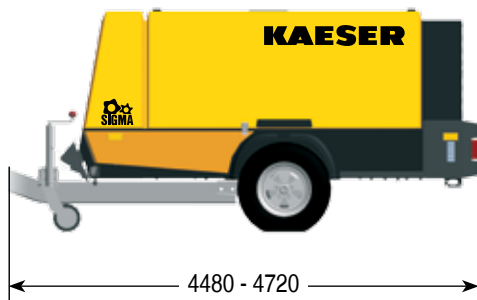

Technical Specifications – MOBILAIR M 122

Model	Compressor unit		4-cylinder diesel engine (Water-cooled)					Compressor unit				
	Free air delivery m³/min	Working pressure bar	Make	Model	Rated engine power kW	Speed at full load rpm	Idling speed rpm	Fuel tank capacity l	Operational weight kg	Sound power level dB(A)*	Sound pressure level dB(A)**	Air connection
M 122	11.1 10.1 9.5 8.2 7.3	7 8.6 10 12 14	Deutz	TCD 2012 L4	83	2300	1600	170	1865	<99	70	3 x G¾ 1 x G1½

*) Guaranteed sound power level to directive 2000/14/EC – Stage 2, guaranteed sound power level – **) Surface sound pressure level to ISO 3744, (r = 10 m)

KAESER – The world is our home

As one of the world's largest manufacturers of rotary screw compressors, KAESER KOMPRESSOREN is represented throughout the world by a comprehensive network of branches, subsidiary companies and authorised partners in over 100 countries.

With innovative products and services, KAESER KOMPRESSOREN's experienced consultants and engineers help customers to enhance their competitive edge by working in close partnership to develop progressive system concepts that continuously push the boundaries of performance and compressed air efficiency. Moreover, the decades of knowledge and expertise from this industry-leading system provider are made available to each and every customer via the KAESER group's global computer network.

These advantages, coupled with KAESER's worldwide service organisation, ensure that all products operate at the peak of their performance at all times and provide maximum availability.

